



Sunglo™ Patio Heaters Model A244(V), (E)



The Sunglo™ model A244 suspended heater frees your deck by supporting heaters from above. The distinctive frame works well in a variety of decors. Optional automatic control systems make these heaters easy to operate even though they may be out of easy reach. Heat coverage varies depending on the wind exposure on patio. The average spacing between these heaters is 12 feet.

This heater is available with a variety of control systems. Each control system is equipped with 100% safety shutoff. The A244 is a manual heater requiring no electrical hookup. The A244V with solenoid gas valve allows the heater to be turned OFF/ON at the turn of a switch. The A244E offers a completely automated ignition system. Both the A244V and A244E requires an external 24 VAC source.

This heater offers a large deep aluminum disk reflector for maximum comfort, a primary aerated burner to minimize noise, and 100% safety shutoff. The wrought iron frame with classic metal scroll design comes in a black powder coat finish.

Specifications:

Input Rating	50,000 BTU/HR
Fuel Type	Natural Gas
Ignition	Pilot or Electronic
Electrical (A244V & E)	24 VAC - 20 VA
24 VAC Transformer	Not Included
Wind Rating	10 mph Horizontal
Nominal Spacing	12 feet
Mounting	Suspended
Manufactured	United States
Certification	CSA International
Warranty	One Year / Parts Only
Weight	49 lbs

Mfr. by:

INFRARED DYNAMICS, INC.

3830 Prospect Avenue

Yorba Linda, CA 92886

Toll Free: 1-888-317-5255

www.infradyne.com

PSA265 (V) (E)

A242

A244 (V) (E)

A270

Sunpak S25, S34



Sunglo™ Patio Heaters Model A244(V), (E)

A244 heaters require no electrical connection and are the easiest to service and maintain. This heater utilizes a pilot-thermocouple 100% safety shutoff. Pilot must be manually lit. Heater is turned off/on with a manual control knob located at front of the heater.

A244V heaters require electrical 24 VAC to be connected in order to operate the main burner. This heater utilizes a pilot-thermocouple with 100% safety shutoff. Pilot must be manually lit. Heater is turned off/on with an electrical switch, timer or other control device by interrupting the 24 VAC supply to the heater. Control device to be supplied by the installer. Manual control knob must be set to the ON position for this heater to operate with an electrical switch.

A244E heaters require 24 VAC electrical to be connected in order to operate. This heater utilizes an electronic ignition and monitors the heater through flame rectification. Heater cannot be manually lit. Heater is turned off/on with electrical switch, timer or other control device by interrupting the 24 VAC supply to the heater. Control device to be supplied by the installer.

The required clearance from combustible materials must be maintained on all heaters. In addition heaters must have adequate fresh air and ventilation to operate properly. Make sure you can meet these requirements in making your heater selection.

This specification sheet was designed as a brief summary about this heater. The primary use of this sheet should be for heater selection only. It should not be used as the sole guide for placement and installation of these heaters. Complete installation instructions can be obtained by calling toll free at 1-888-317-5255 and online at www.infradyne.com.

Suggested Specifications:

Heater shall be Sunglo™ models A244, A244V, or A244 as manufactured by Infrared Dynamics, Inc., Yorba Linda, California. All heaters shall be equipped with a control system for use with natural gas fuel. Each heater shall have passed the ANSI requirements for outdoor heaters.

Reflector shall be of a deep disk circular type mounted on top of heater.

Infrared Emitter shall be made of perforated stainless steel.

Each heater shall be equipped with a 100% safety shutoff device.

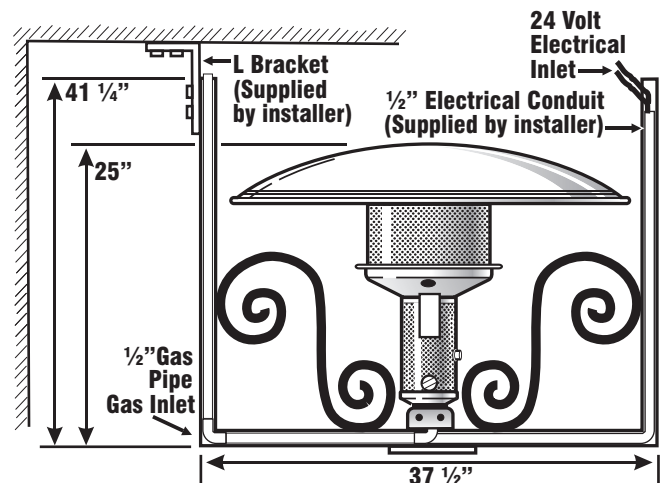
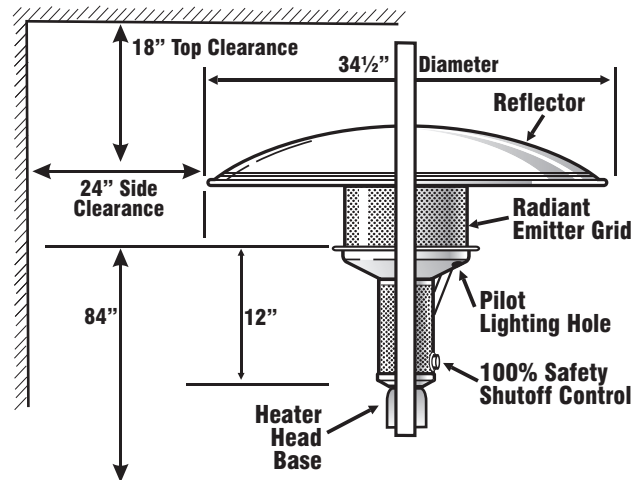

ELECTRICAL HOOKUP (A244 Only)

